

TRIPLE PORT DB25F TO DB9M/DB9M CONNECTOR RIGHT ANGLE TYPE

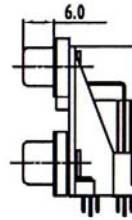
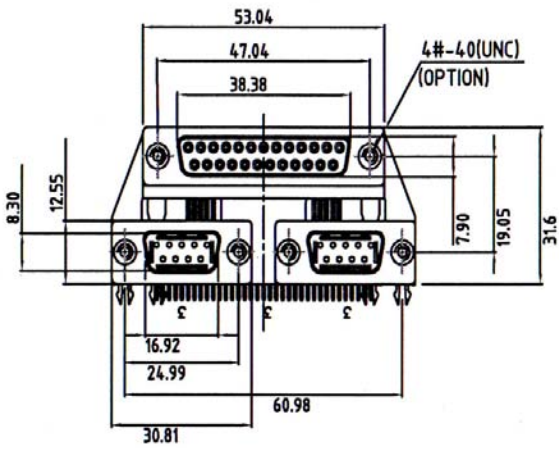

SPECIFICATIONS

Current Rating: 3.0 Amperes
 Contact Resistance: 25mΩ Max.
 Insulation Resistance: 1000MΩ Min. at 500V
 Dielectric Voltage: 1000V at 1 Minute
 Operating Temperature: -55°C to +105°C

MATERIALS

Insulator: PBT, UL94V-0 Rated
 Contact: Brass
 Shell: Brass, Steel
 Contact Plating: Gold Over Nickel Plated
 Shell Plating: Tin Over Copper Plated
 *RoHS & REACH compliant.

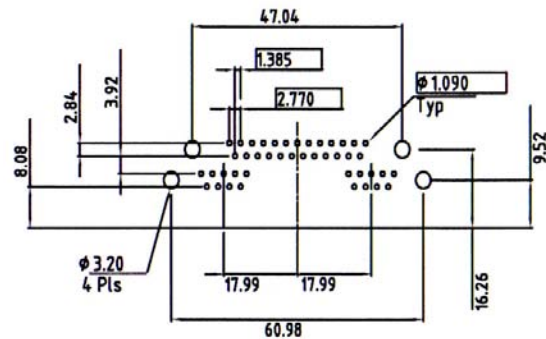
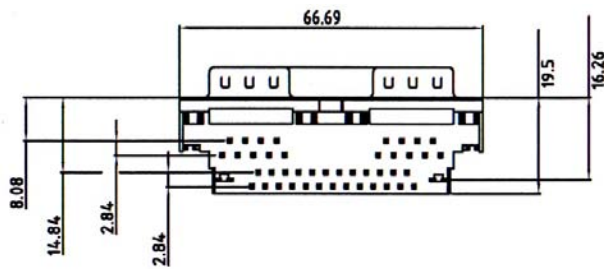

Recommended P.C. Board Layout

N	NJ	NH

ORDERING INFORMATION:

P/N TP25F-9M9M/A XX
 I

1. MOUNTING OPTION:

- "N" #4-40UNC THREADED HOLES WITHOUT HEX SCREW BOLTS
- "NH" #4-40UNC THREADED HOLES WITH BULK-PACKED (LOOSE) #4-40UNC HEX SCREW BOLTS
- "NJ" #4-40UNC THREADED HOLES WITH INSTALLED (ASSEMBLED) #4-40UNC HEX SCREW BOLTS

NOTE: PC99 FOLLOW PANTONE COLORS:

- 1. UPPER PORT: PURPLE (DB25F)
- 2. LOWER PORT: GREEN (DB09M)

TRIPLE PORT DB25F TO DB9M/HD15F CONNECTOR RIGHT ANGLE TYPE

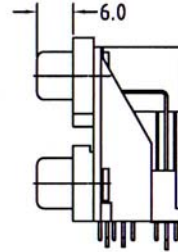
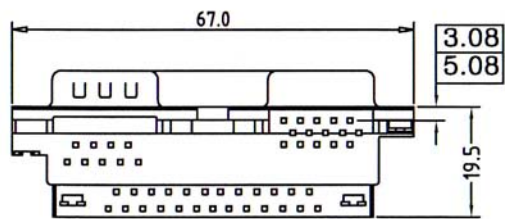
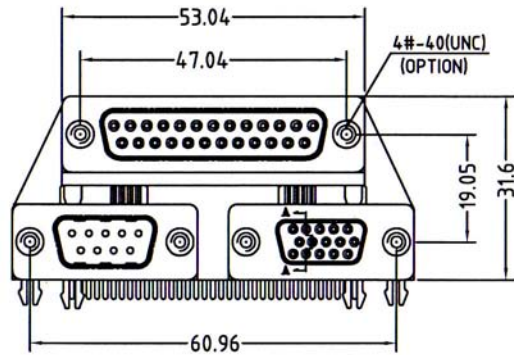

SPECIFICATIONS

Current Rating: 3.0 Amperes
Contact Resistance: 25mΩ Max.
Insulation Resistance: 1000MΩ Min. at 500V
Dielectric Voltage: 1000V at 1 Minute
Operating Temperature: -55°C to +105°C

MATERIALS

Insulator: PBT, UL94V-0 Rated
Contact: Brass
Shell: Brass, Steel
Contact Plating: Gold Over Nickel Plated
Shell Plating: Tin Over Copper Plated
 *RoHS & REACH compliant.

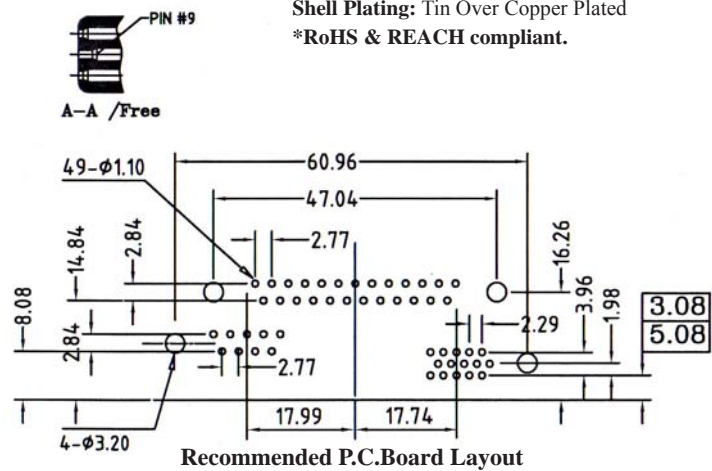

N	NJ	NH

ORDERING INFORMATION:

P/N TP25F-9MHD15F/A XX
I

1. MOUNTING OPTION:

- "N" #4-40UNC THREADED HOLES WITHOUT HEX SCREW BOLTS
- "NH" #4-40UNC THREADED HOLES WITH BULK-PACKED (LOOSE) #4-40UNC HEX SCREW BOLTS
- "NJ" #4-40UNC THREADED HOLES WITH INSTALLED (ASSEMBLED) #4-40UNC HEX SCREW BOLTS

NOTE: PC99 FOLLOW PANTONE COLORS:

1. UPPER PORT: PURPLE (DB25F)
2. LOWER PORT: GREEN (DB09M)
3. LOWER PORT: BLUE (HD15F)