

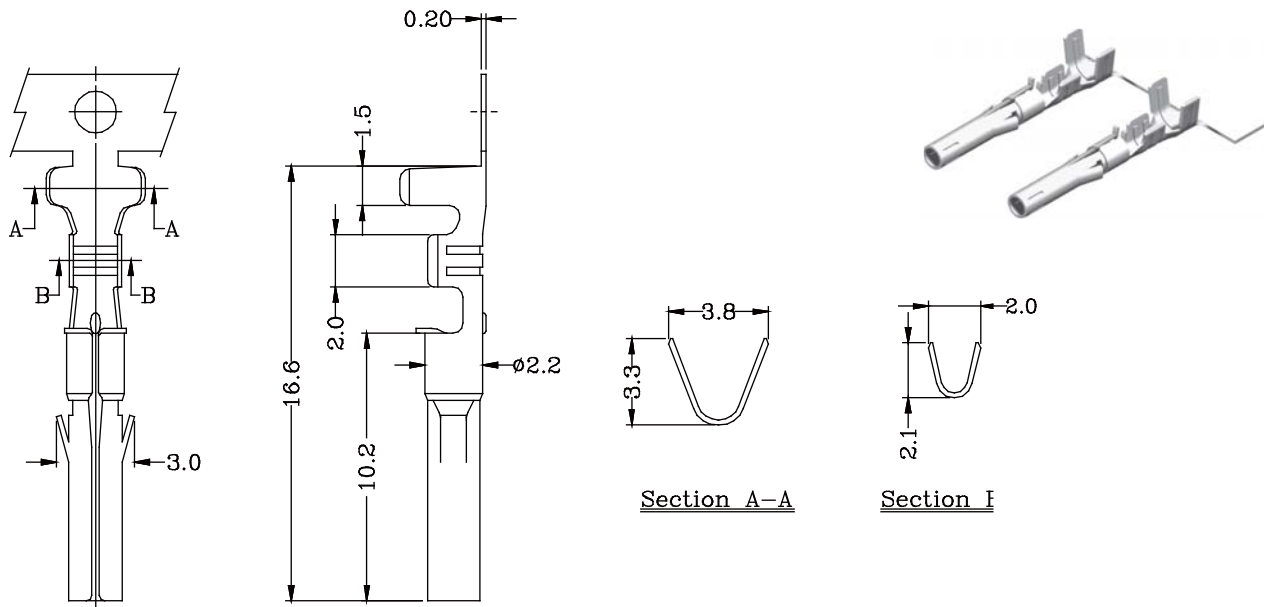

4.8mm Female Terminal / Male Housing



Wire Range	Insulation O.D.	Material	Finish
AWG#20-#24	1.85mm(max)	Brass	Tin-Plated

Part No.:4800-FT-L

Specifications

Current Rating: 5A AC,DC
 Voltage Rating: 250V AC,DC
 Temperature Range: -25°C to +85°C
 Contact Resistance: 10mΩ Max
 Insulation Resistance: 1000MΩ Min
 Withstanding Voltage: 1500V AC/minute
 Material: Nylon 66,UL94V-2

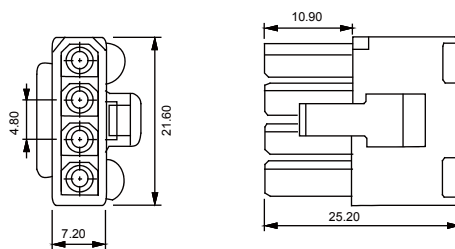

4800H-M104W-L

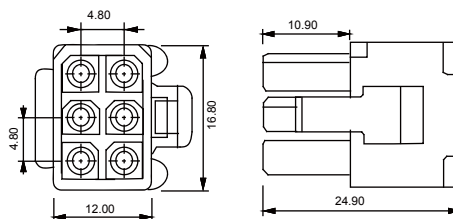
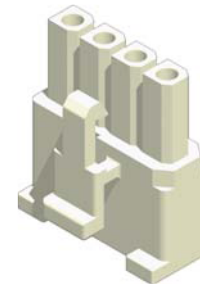

4800H-M203W-L

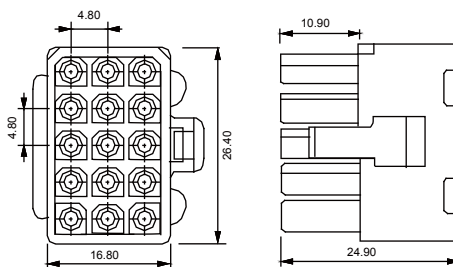

4800H-M305W-L

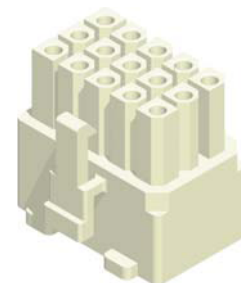

Part No.	No. of Contacts
4800H-M102W-L	1x2
4800H-M103W-L	1x3
4800H-M104W-L	1x4
4800H-M203W-L	2x3
4800H-M303W-L	3x3
4800H-M304W-L	3x4
4800H-M305W-L	3x5

Part No.:4800H-MXXXW-L



4.8mm Male Terminal / Female Housing

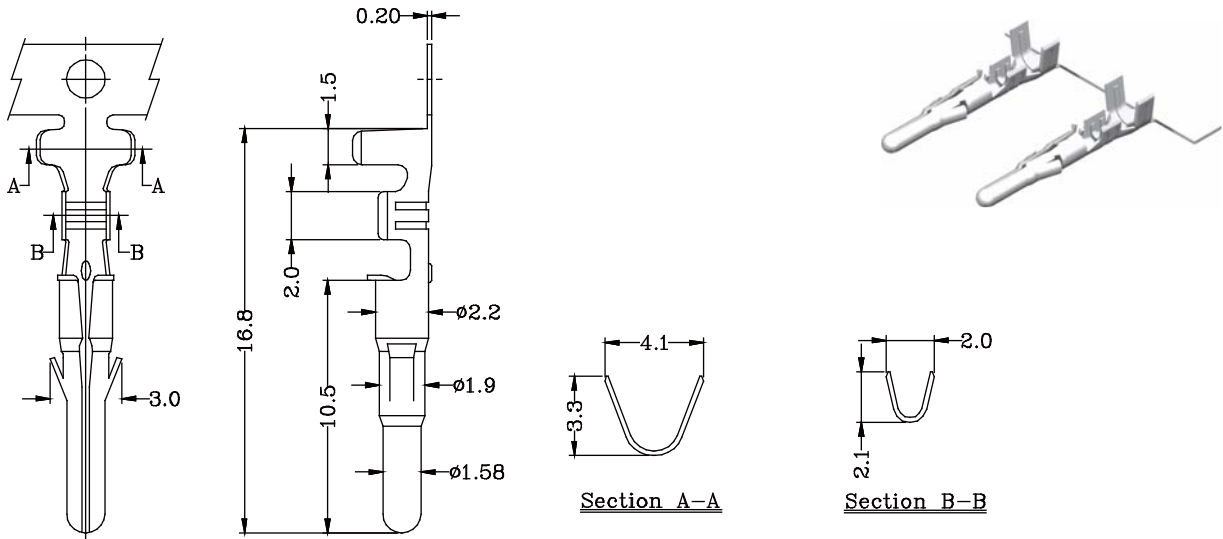

Part No.:4800-MT-L

Wire Range	Insulation O.D.	Material	Finish
AWG#20-#24	1.85mm(max)	Brass	Tin-Plated

Specifications

Current Rating: 5A AC,DC
 Voltage Rating: 250V AC,DC
 Temperature Range: -25°C to +85°C
 Contact Resistance: 10mΩ Max
 Insulation Resistance: 1000MΩ Min
 Withstanding Voltage: 1500V AC/minute
 Material: Nylon 66,UL94V-2

Part No.	No. of Contacts
4800H-F102W-L	1x2
4800H-F103W-L	1x3
4800H-F104W-L	1x4
4800H-F203W-L	2x3
4800H-F303W-L	3x3
4800H-F304W-L	3x4
4800H-F305W-L	3x5

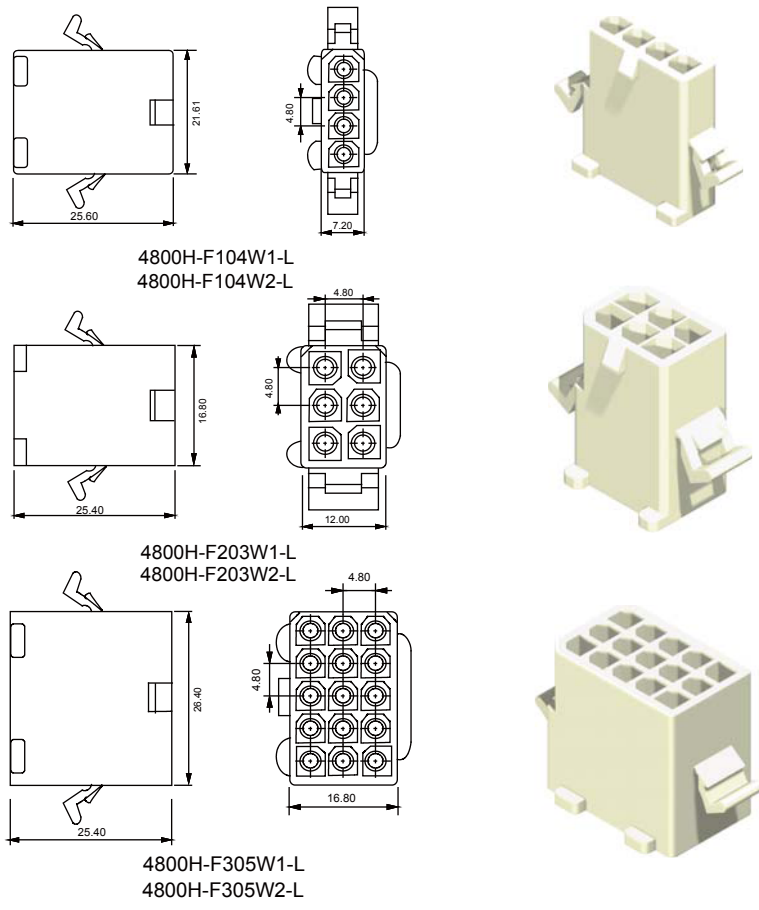

Part No.:4800H-FXXXW□-L

1:With Ear
2:W/O Ear